

**CREATE YOUR OWN
MONSTER**
FRANKENSTEIN
Made with Pride **TRIKES** Pleasanton, KS, U.S.A.

Installation Guide

**FLT/FLH
ROAD KING**

38" Sport Trike Kit

All Years



INCLUDED IN YOUR TRIKE KIT:

COMPONENTS

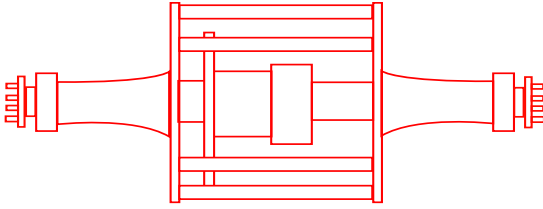

Frankenstein Trikes Rear End

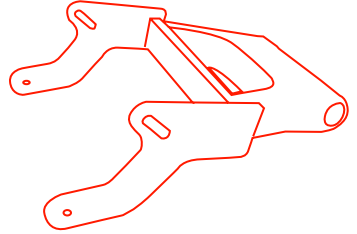

Swing Arm

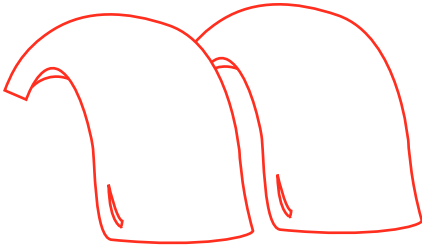

2 Long FI Style fenders

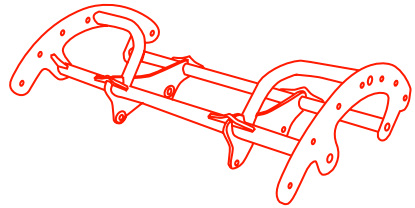

FL style fender bracket

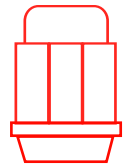
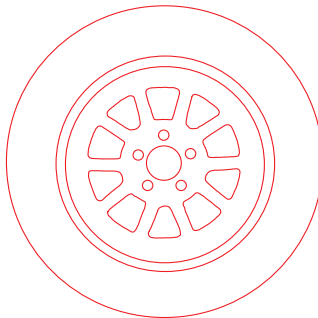
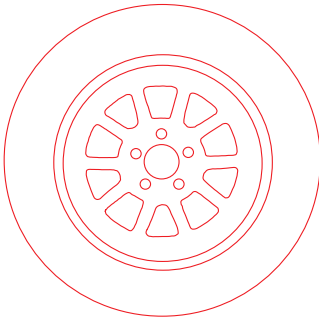

10 lug nuts

2 Race Star 15" X 8" wheels style FST-10-580146-SM

1 2 Center caps and 2 General Altimax 215/60R15 tires

HARDWARE

PULLEY MOUNTING

pre-installed onto the rear end.

- 5 pcs. - 7/16" -14 x 2" Grd. 8 (Gold) Bolt ('00 & up)
- 5 pcs. - 7/16" -14 x 1 1/2" Grd. 8 (Gold) Bolt ('99 & down)
- 5 pcs. - 7/16" Lock Washer

FENDER MOUNTING

- 14 pcs. - 3/8" - 16 x 1" Grd. 5 (Zinc) Bolt
- 14 pcs. - 3/8" I.D. 1" O.D. 1/16" Thick Grd 5 Washer
- 14 pcs. - 3/8" -16 Nylock Nut

NOTE! Additional hardware used to mount fender brackets to the rear end are pre-installed onto the rear end.

SHOCK MOUNTING

- 2 - 1/2" - 13 x 4" Grd 8 Bolt (Upper Shock)
- 2 - 1/2" I.D. 1 1/4" O.D. x 1 1/2" Long Spacer (Upper Shock)
- 2 - 1/2" - 13 x 6" Grd 8 Bolt (Upper Shock) (95-97)
- 2 - 1/2" I.D. 1 1/4" O.D. x 1 1/2" Long Spacer (Upper Shock) (80-95)
- 2 - 1/2" I.D. 1 1/4" O.D. x 2" Long Spacer (Upper Shock) (96-01)
- 2 - 1/2" I.D. 1 1/4" O.D. x 1 3/4" Long Spacer (Upper Shock) (02-08)
- 2 - 1/2" I.D. 1 1/4" O.D. x 1 5/8" Long Spacer (Upper Shock) (09 & up)

WHEEL MOUNTING

- 10 - Lug Nuts



LOCTITE is included with every kit and must be used where instructed in this manual.

STAGE 1. Motorcycle Preparation:

 Always refer to your Harley-Davidson owners manual before performing any work on your bike.

1. Secure front wheel so motorcycle won't tip, set jack under the motorcycle and raise the jack to take the weight off of the rear wheel.

 *mufflers will be to long for your Frankenstein Trike Kit.*

2. Remove mufflers and lower belt guard.



3. Remove saddle bags, saddle bag support & crash bar

4. Remove banjo bolt from caliper

 **TIP** Once the brake line is unhooked from caliper, make sure to hang line upright so no fluid leaks out and no air gets trapped in the brake line.

5. Remove axle from wheel and swing arm. Move wheel forward to be able to slide the belt off of the pulley.

6. Slide the belt off of the pulley.

7. Remove rear wheel, you may need to raise the jack to get the

3 wheel out from under the bike.

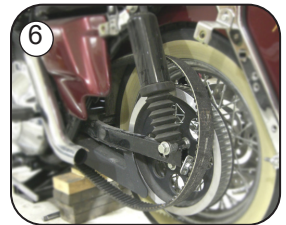

8. Lower the bike down, place wood blocks under the transmission to support the transmission for removal of the swing arm.

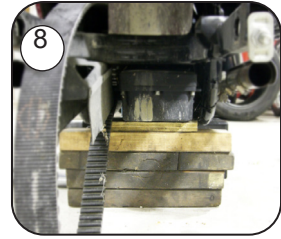

9. Have a friend help while you remove the pivot shaft nut from left side of bike.

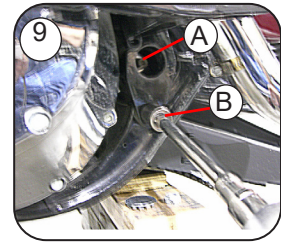

10. Remove lower shock bolts.



11. Remove pivot shaft mounting bracket left side only. Using a suitable drift, tap the pivot shaft out of the swing arm. Remove swing arm.



10. Remove lower shock bolts.

11. Remove pivot shaft mounting bracket left side only. Using a suitable drift, tap the pivot shaft out of the swing arm. Remove swing arm.



Note: the positions of the spacers on original swingarm, these will need to be placed in the same positions on your new swing arm.

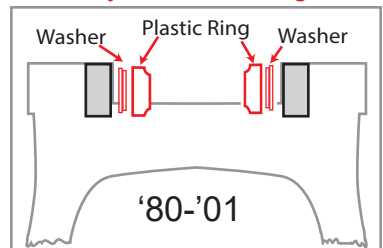
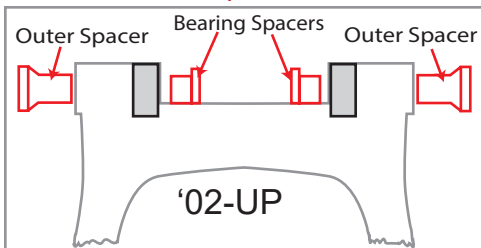

Now would be a good time to check the condition of your pulley and belt.

STAGE 2. Rear End Preparation/Installation:

★ 38" and longer rear ends are shipped with one or both axles not installed in the rear end. To install axles, remove the axle retainer plate (see diagram 13 pg. 7) and insert axle. Reinstall bolts, loctite and torque to 31 ft. lbs.

1. With swing arm and rear wheel removed, have a friend help set a wheel and tire on the brake side of the rear end. Install with lug nuts.

TIP Install center cap into wheel before mounting.

2. Set the rear end on the wheel that was previously installed. Remove the five bolts to the spokes, Remove axle, axle housing and star plate as a unit.



Do not remove green tape, it will be used as a reference point in the following instructions.

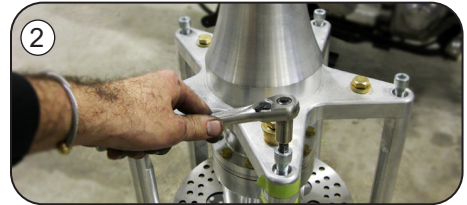

3. If you have a 1999 and earlier FLT with a pulley or sprocket that has a center hole with a diameter of approximately 1.980" (50.292mm) then your pulley or sprocket will need to be machined. Install tool as shown using supplied bolts. Place back side of tool onto lathe chuck. Use boring tool to expand the diameter of the center hole. Measure frequently while boring until the diameter of the center hole is 2.212" (56.185mm). If your FLT is 2000 and later go to next step.

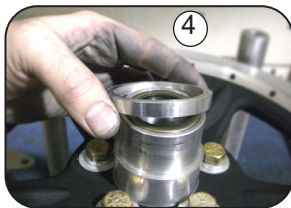

shown '00 and up

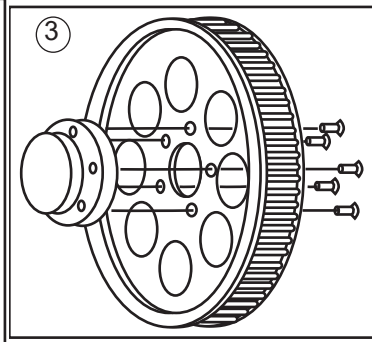
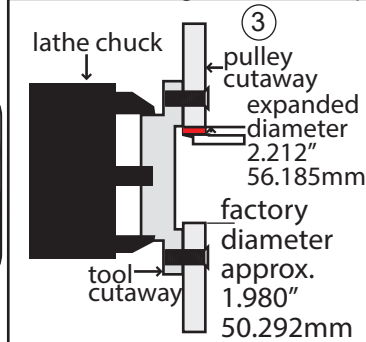

4. Install Pulley. Install 7/16" pulley bolts with lock washers provided apply **red loctite** and torque the pulley bolts. Have friend help hold the center section of the rear end with a screw driver through a hole in the rotor and through one of the holes in the star plate.
5. Torque the pulley bolts to 65 ft. lbs. Insert spacer

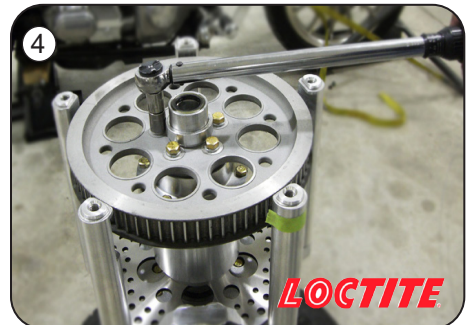

5. Before installing the new swing arm remove the rubber isolator from the swing arm mount.



6. Insert white delrin bushing into rubber isolator be sure to center the center hole of the delrin bushing on the mounting hole of the rubber isolator.



7. Install rubber isolator with delrin bushing on both sides of trike per Harley manual.

8. Install modified swing arm. Install pivot shaft, pivot shaft mounting bracket, the roll pin on each mounting bracket must register in the rubber mount locating hole. Torque pivot shaft mounting bracket bolts 34 to 42 ft. lbs. Install pivot shaft nut left side. Torque swing arm pivot shaft nut to 45 ft. lbs.



9. Prepare a Block and position rear end as shown to the right.

10. Slide the rear end under the bike. Lower the jack and set belt on pulley. (This is a little tricky but have patience) This is shown with a 65 tooth pulley. For a larger pulley you may need to loosen the spokes on the opposite side of rear end to accommodate the belt installation. You may have to work around each spoke spreading then inserting belt while lifting the axle.



11. Slide drive side star plate onto rear end differential housing, align the star plate with the spoke that was marked with the green tape. Start all 1/2" allen bolts on star plate into spokes, tighten evenly. **DO NOT FORCE BOLTS IN**

12. Remove the 1/2" allens one at a time apply blue loctite and reinstall torque 60 ft. lbs. Both Sides.



13. Install lower swing arm mounting bolts both side leave loose. Install upper swing arm mounting bolts, make sure to put the washer between the swing arm and the star plate on both sides leave loose. Refer to diagram for placement of washers and spacers.

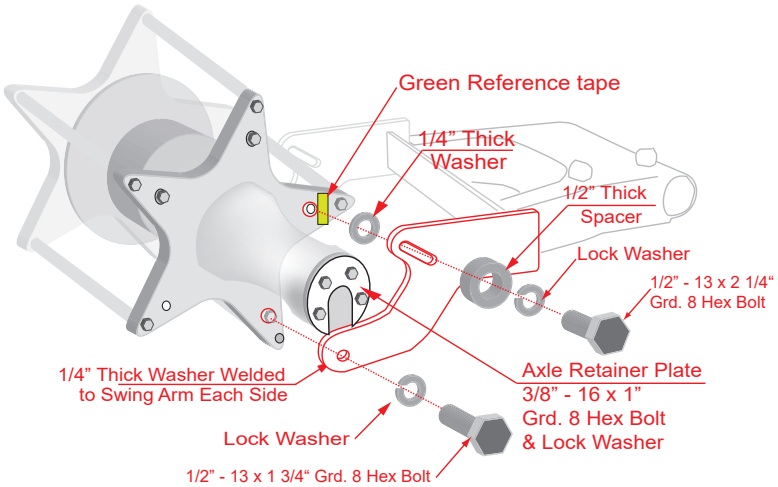
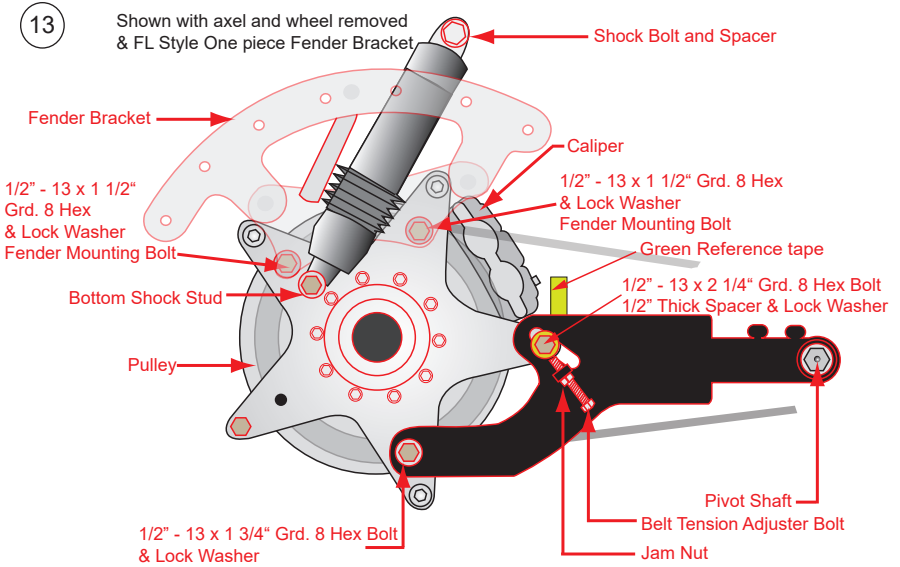

14. Drill small hole in the fender to move the air shock line back about 1”.

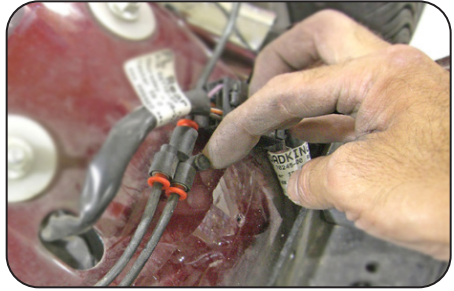

15. Install wheel on left side. Install shocks both side. (If you are installing fenders the shock will have to be removed for installation of the fenders and fender bracket.)

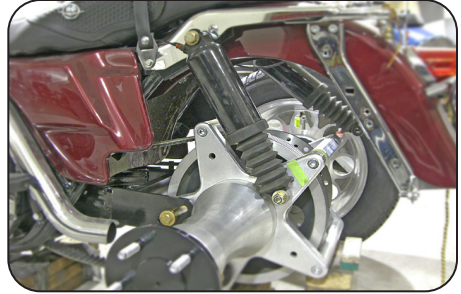

16. Install brake line to rear caliper and bled.

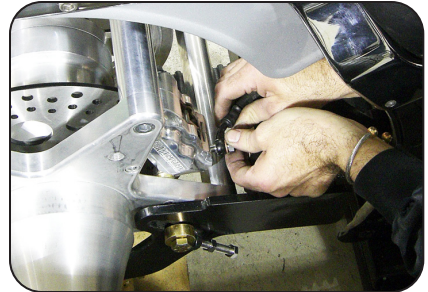

⚠ *The trike must be sitting on the ground on its suspension to adjust the belt. Shown without wheel and on blocks for photography.*

17. Adjust belt tension to factory specs.

18. Tighten jam nut on adjuster bolts.

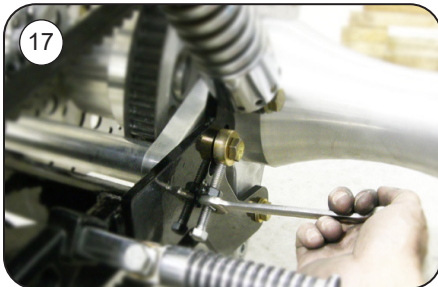

⚠ *The trike must be sitting on the ground on its suspension to adjust the belt. Shown without wheel and on blocks for photography.*

19. Torque the four rear end mounting bolts to 60 ft. lbs.

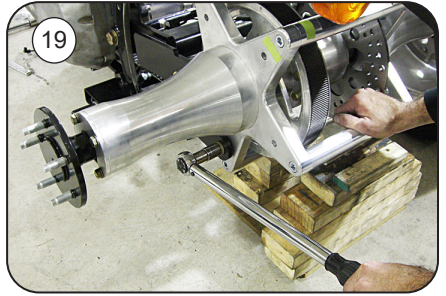
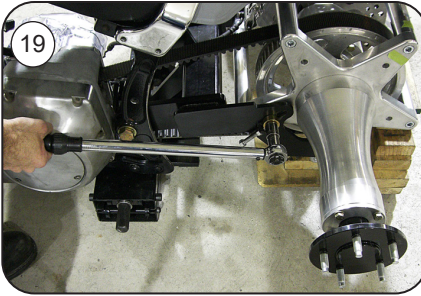

20. Attach fender brackets to fenders using supplied FENDER MOUNTING HARDWARE. See diagram for proper installation.

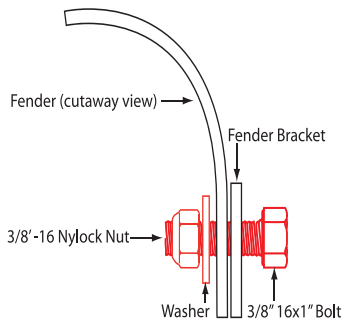
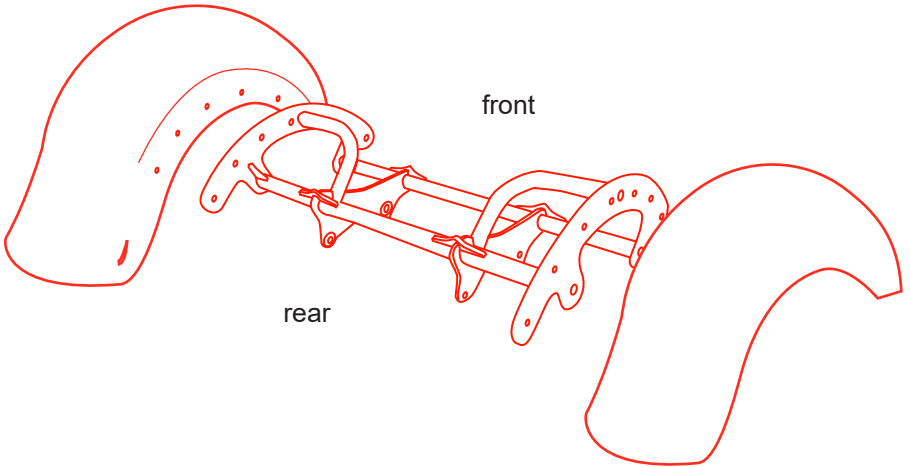

**Configuration A. (standard)
for 15x8 wheels & tires
and 11" FL style fenders**

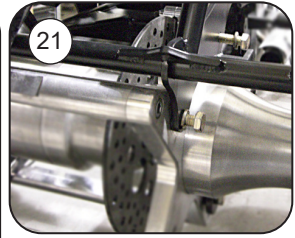
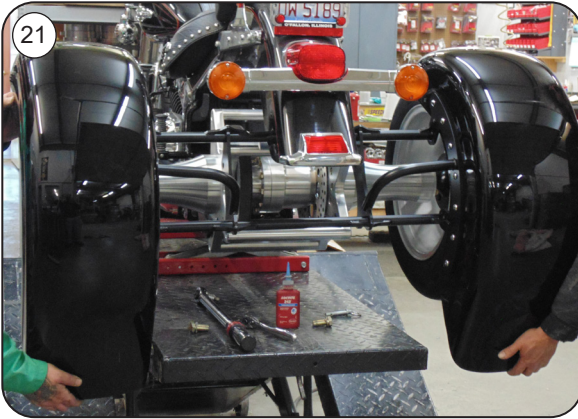

21. Remove two gold bolts on both sides. Install fender and bracket on the rear end.

22. Torque upper fender bracket bolts to 60 ft. lbs

23. Tighten lug nuts on rear wheels torque 78 to 85 ft. lbs. and go for a ride. Re-torque lug nuts after 25 miles or 100 mile maximum.

Tip: Recommended tire pressure is 25psi.



Note: Initially the brake and rotor need to be worn in before maximum braking can be achieved. Please use caution.



Our Trike rear ends are made from all 6061 T6 billet aluminum, except for our Light Sport Std. Trike rear end, which has 3/8" thick steel star plates, powder coated silver, instead of 1" thick billet aluminum star plates that we use on all our other Trike rear ends.

All of our rear ends have a Dana 30 differential, packed with Moly EP grease. 9" Ford street/strip axles with a bolt pattern of 5 studs on 4 1/2" bolt circle, wheel studs are 1/2" -20. HHI/Frankenstein 4 piston billet caliper, 11 1/2" stainless steel brake rotor, or optional outboard Brakes with two HHI/Frankenstein 4 piston billet calipers and two 11" stainless steel brake rotors. We only use top quality new parts in our manufacturing of "Frankenstein Trikes" rear ends.

Replacement Parts

Differential seal: National oil seal # 481213 \$3.50 each

Differential Bearing: # 62102RS \$15.00 each

Axle Bearing: BCA # RW207-CCRA \$55.00 each

Brake Pads: HHI-101-001 \$30.00 pair

prices subject to change

